

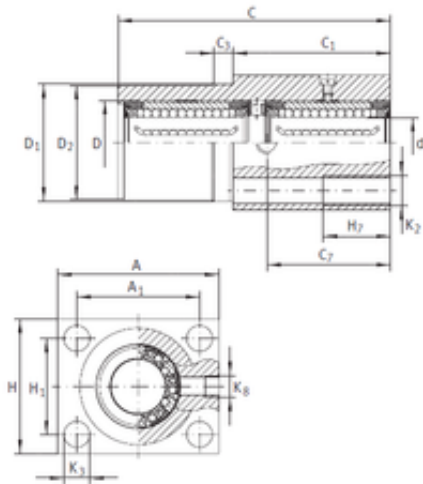

Thk Environmental Axis.



KTFN 20 C-PP-AS Bearing 2D drawings and 3D CAD models

INA KTFN 20 C-PP-AS Cojinetes Lineales

Bearing No. KTFN 20 C-PP-AS

Bore Diameter	20 mm
Outer Diameter	32 mm
d	20 mm
D	32 mm
C7	48 mm
H7	22 mm
K8	8,4 mm
Thread (K2)	M10
Thread (K8)	M8X1
C3	10 mm
A	60 mm
A1	45 mm
C	96 mm
C1	60 mm
D1	42 mm
D2	41,8 mm
H	50 mm
H1	35 mm
Weight	0,5 Kg
Basic dynamic load rating (C)	2,85 kN